

- ALL STEEL CONSTRUCTION
- MAXIMUM SIZE AVAILABLE = 24 X 24
- FINISH: GOLDEN SAND (GS) ENAMEL

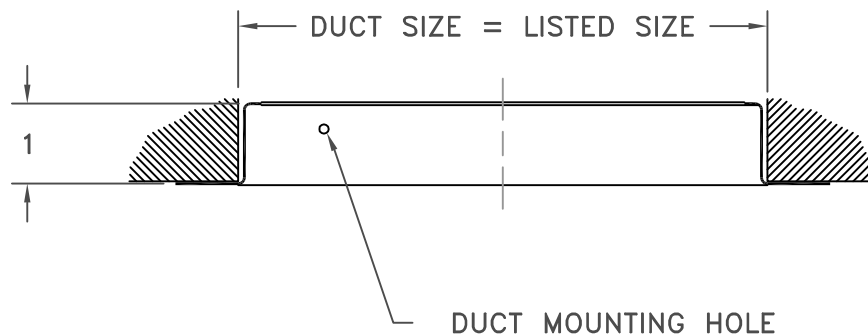
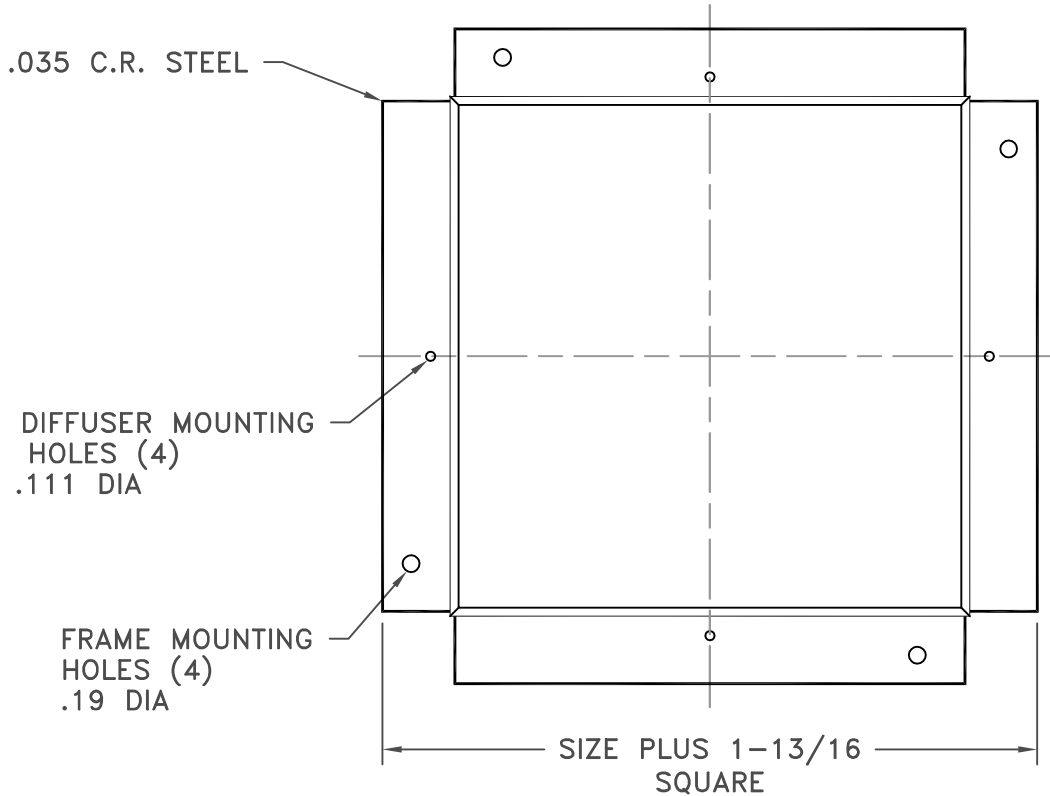

JOB NAME: _____	SUBMITTED BY: _____	DATE: 08/26/2013 SD-2210
LOCATION: _____		NO. 21 Installation Frame
ARCHITECT: _____		
ENGINEER: _____		
CONTRACTOR: _____		